



苏州敏芯微电子技术股份有限公司
MEMSensing Microsystems (Suzhou, China) Co., Ltd.

Data Sheet

V 1.0 / Nov. 2019

MSM38A2718Z9EM2

Analog output MEMS microphone

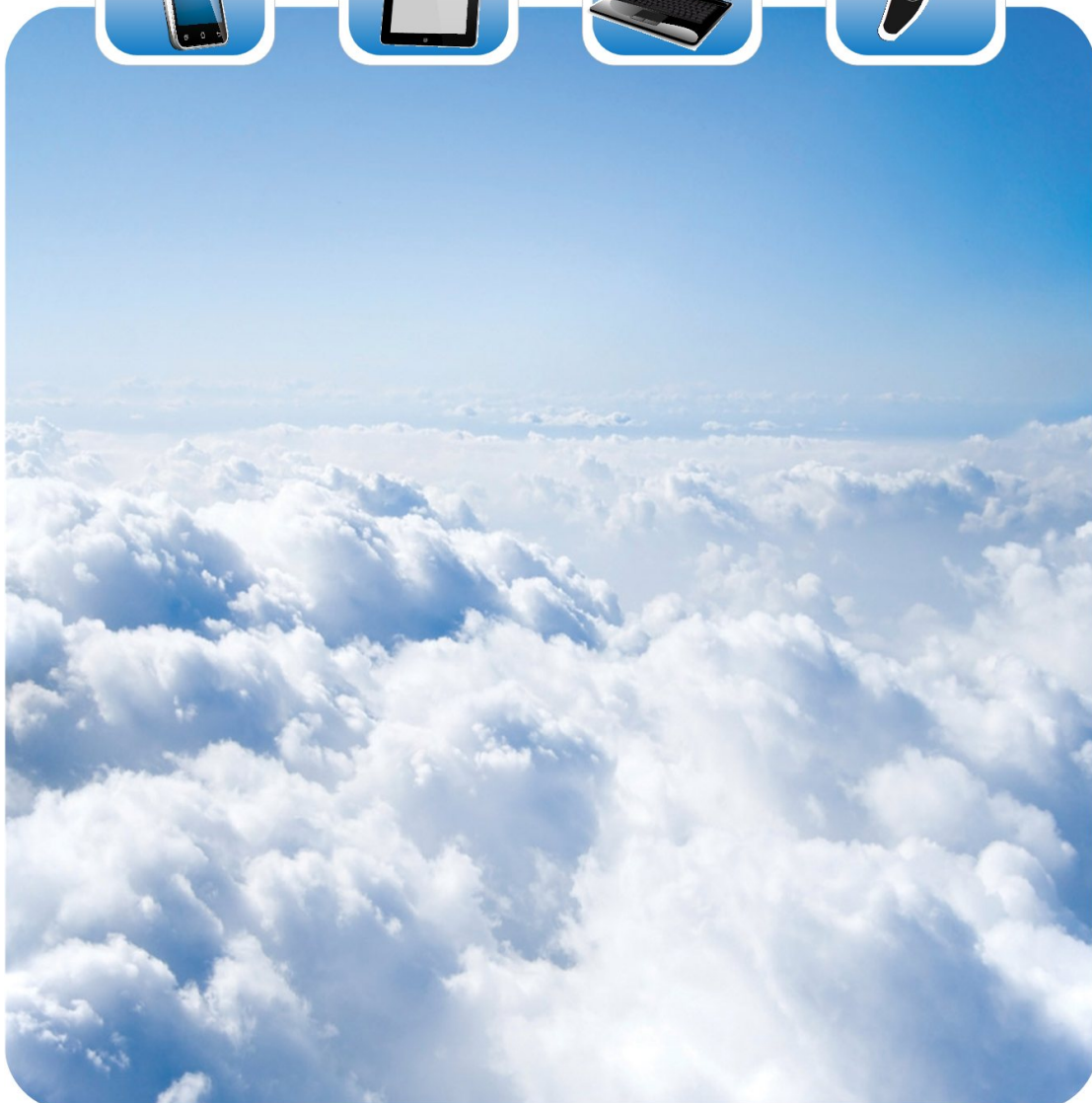

MSM38A2718Z9EM2

Analog output MEMS microphone



GENERAL DESCRIPTION

MSM38A2718Z9EM2 is an omnidirectional, Bottom-ported, analog output MEMS microphone. It has high performance and reliability. It is with enhanced RF immunity performance .

MSM38A2718Z9EM2 is available in a thin 2.75 mm × 1.85 mm × 0.9 mm metal can LGA package. It is SMT compatible with no sensitivity degradation.

FEATURES

- ✧ Omnidirectional
- ✧ Excellent RF immunity
- ✧ Standard SMD Reflow
- ✧ Compatible with Sn/Pb and Pb-free solder processes
- ✧ RoHS/Halogen free compliant

APPLICATIONS

- ✧ Mobile Phone
- ✧ Laptop
- ✧ Tablet computer
- ✧ Bluetooth headset
- ✧ Earphone
- ✧ Wearable intelligent equipment

PRODUCT VIEW

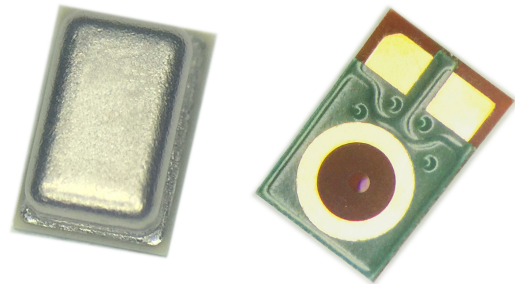

MSM38A2718Z9EM2

Analog output MEMS microphone



苏州敏芯微电子技术股份有限公司
MEMSensing Microsystems (Suzhou, China) Co., Ltd.



ABSOLUTE MAXIMUM RATINGS

Parameter	Maximum value	Unit
Supply Voltage	-0.3 to 4.0	V
Sound Pressure Level	140	dB SPL
Storage temperature	-40 to 100	°C

Stresses exceeding these “Absolute Maximum Ratings” may cause permanent damage to the device. These are stress ratings only. Functional operation at these or any other conditions beyond those indicated under “Acoustic & Electrical Specifications” is not implied. Exposure beyond those indicated under “Acoustic & Electrical Specifications” for extended periods may affect device reliability.

ACOUSTIC & ELECTRICAL SPECIFICATIONS

All data taken at 25°C, Relative Humidity 45±5% unless otherwise specified					
	Limits			unit	condition
	Min.	Nom.	Max.		
Directivity	Omni directional				
Sensitivity	-41	-38	-35	dB	@1kHz ref 1V/Pa
Operation voltage	1.5	-	3.6	V	
Freq. range	Refer to the frequency response graphic			Hz	Ref to sensitivity@1kHz
Sensitivity loss across supply voltage	No change across the voltage range			dB	
Signal to noise ratio	-	62	-	dB	20 kHz bandwidth, A-weighted
THD	-	0.1	-	%	94dB SPL @1kHz S =Nom, Rload > 2 k
AOP	-	123	-	dB SPL	10% THD @1kHz S =Nom, Rload > 2 k
Polarity	Increasing output voltage				Increasing sound pressure
Output impedance	-	200	-	Ω	@1kHz
DC Output		0.7		V	
PSRR	-	70	-	dB	200mVpp sine wave @ 1 kHz, VDD = 1.8V
PSR	-	-100	-	dBV(A)	100 mVpp square wave @ 217 Hz, VDD = 1.8V, A-weighted
Current consumption	-	150	170	μA	



TYPICAL FREQUENCY RESPONSE

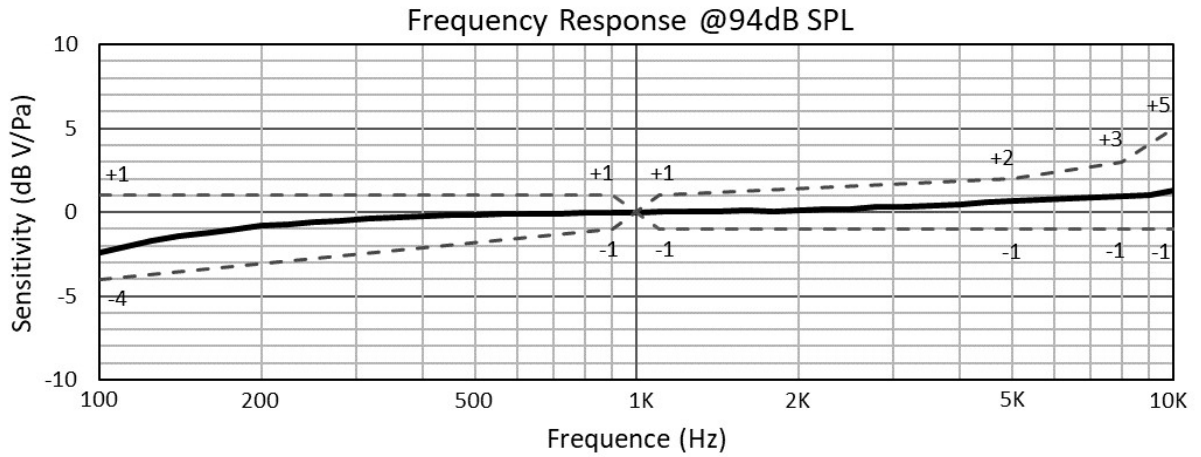

SMT Parameters:

1. Recommend PCB land pattern & stencil pattern layout: (unit: mm)

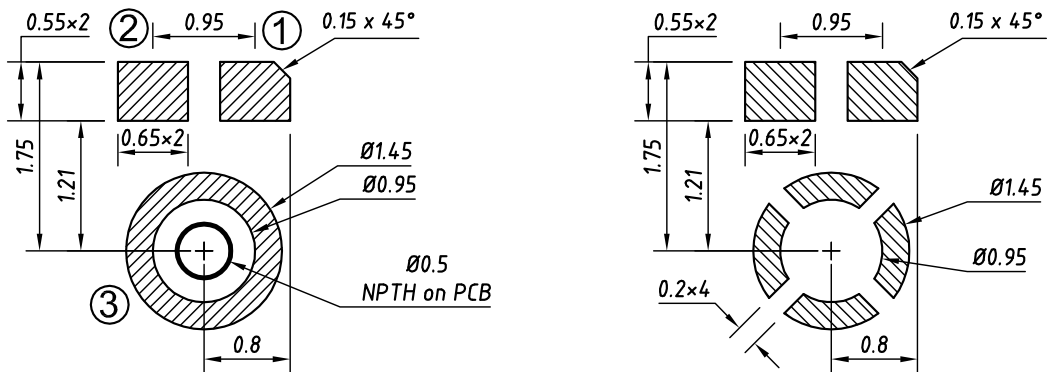



2. Recommend reflow profile:

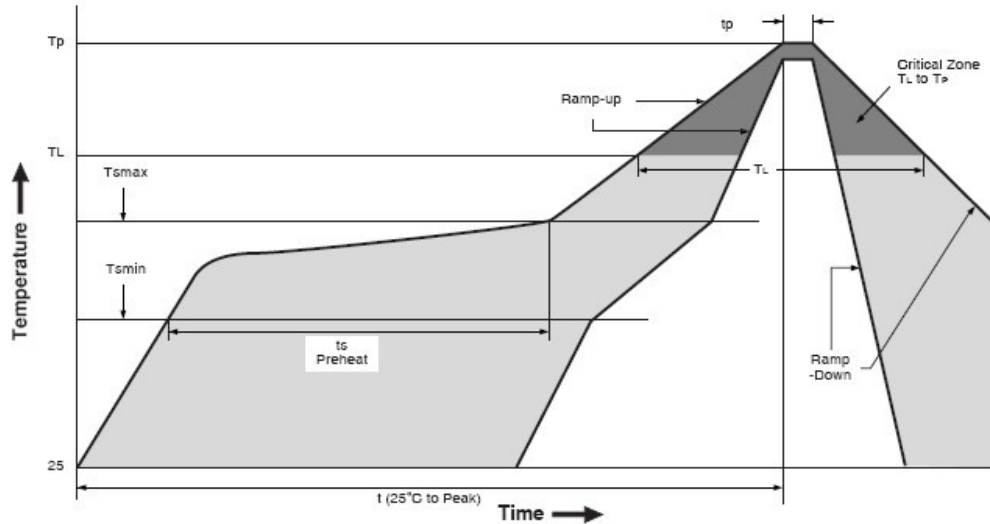

Description	Parameter	Pb-free
Average ramp-up rate	T_{smax} to T_P	3°C/sec max
Preheat		
Minimum temperature	T_{SMIN}	150 °C
Maximum temperature	T_{SMAX}	200 °C
Time(T_{SMIN} to T_{SMAX})	t_s	60 sec to 180 sec
Ramp-up rate	T_{SMAX} to T_L	1.5 ~ 2 °C/sec
Time maintained above liquidus temperature	t_L	60 sec to 150 sec
Liquidus temperature	T_L	217 °C
Peak temperature	T_P	260 °C
Time within 5°C of actual peak temperature	t_p	20 sec to 40 sec
Ramp-down rate	T_P to T_{smax}	6 °C/sec max
Time 25 °C ($t_{25 °C}$) to peak temperature	t	8 minutes max

NOTE: When MEMS MIC is soldered on PCB, the reflow profile is set according to solder paste and the thickness of PCB etc.



OUTLINE DIMENSIONS AND PIN DEFINITION:

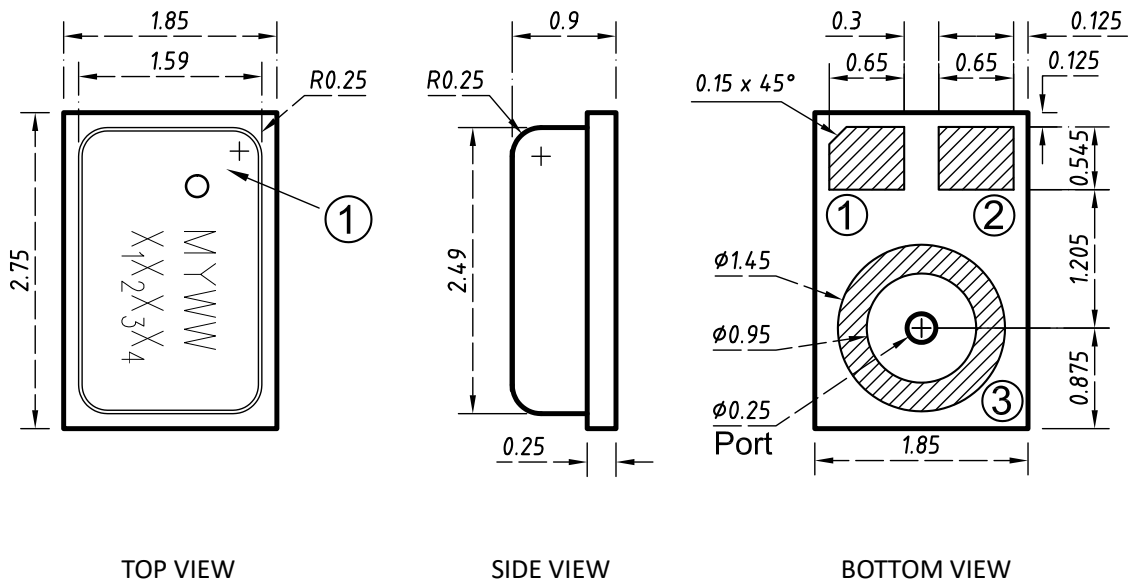
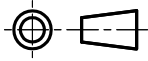

PIN function description

PIN#	Function
1	VDD
2	OUT
3	GND

Item	Dimension	Tolerance
Length (L)	2.75	±0.10
Width (W)	1.85	±0.10
Height (H)	0.90	±0.10
Acoustic Port (AP)	∅0.25	±0.05

Dimensions are in millimeters, tolerance is ±0.15mm unless otherwise specified.

MYWW X ₁ X ₂ X ₃ X ₄	M	Memsensing
	Y	Year(A~Z)
	WW	Week
	X ₁ X ₂ X ₃ X ₄	Serial Number



RECOMMENDED INTERFACE CIRCUIT:

- **Recommended Application Example (differential amplification circuit)**

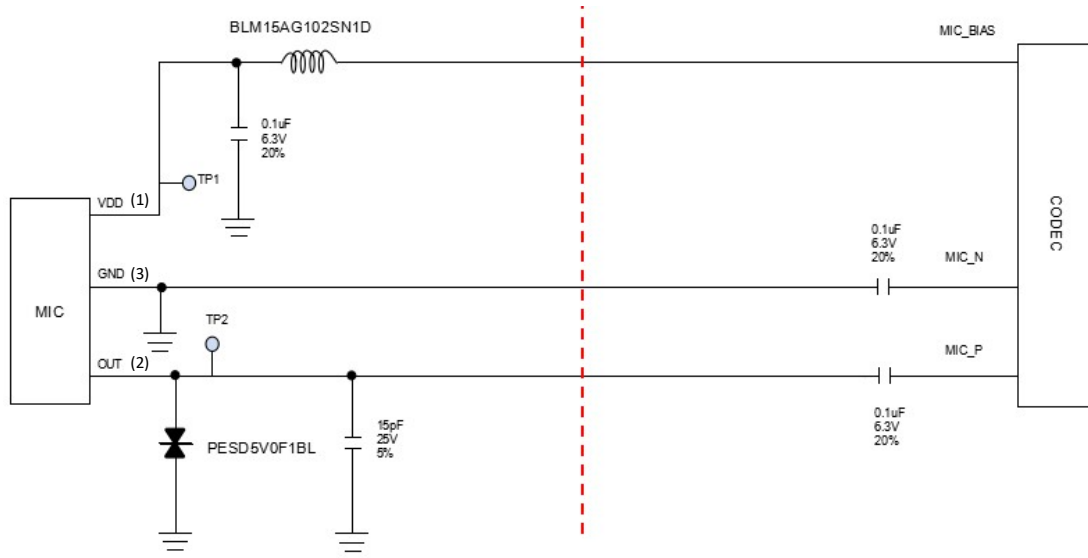

NOTE: It is recommended that the components on the left side of red line be placed close to MIC, and components on the right side of red line be placed close to codec.



ADDITIONAL NOTES

- (A) MSL (moisture sensitivity level) Class 1.
- (B) Maximum of 3 reflow cycles is recommended.
- (C) In order to minimize device damage:
 - Do not board wash or clean after the reflow process.
 - Do not brush board with or without solvents after the reflow process.
 - Do not directly expose to ultrasonic processing, welding, or cleaning.
 - Do not insert any object in port hole of device at any time.
 - Do not apply air pressure into the port hole.
 - Do not pull a vacuum over port hole of the microphone.
 - Do not apply a vacuum when repacking into sealed bags at a rate faster than 0.5 atm/sec.

STORAGE AND TRANSPORTATION

- (A) Keep MEMS MIC in warehouse with less than 75% humidity and without sudden temperature change, acid air, any other harmful air or strong magnetic field.
 - Recommend floor life (out of bag) at factory no more than 4 weeks.
- (B) The MEMS MIC with normal pack can be transported by ordinary conveyances. Please protect products against moist, shock, sunburn and pressure during transportation.

MATERIALS STATEMENT

Meet the requirements of MEMSensing standard on hazard substances control (including RoHS2.0+REACH+Halogen-Free, etc.), with "HSF" identification on label.



PACKAGING & MARKING DETAIL:

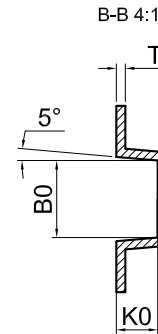
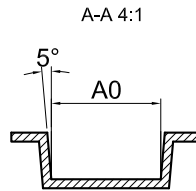
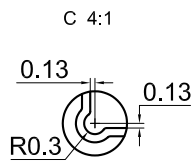
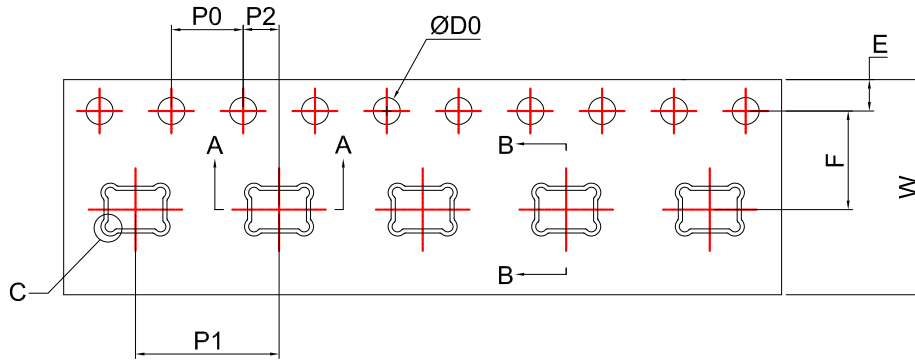

Direction of Feed →

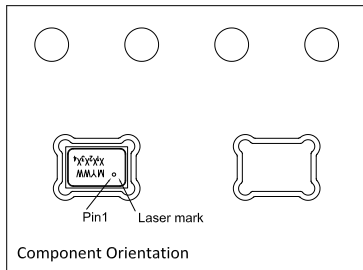

ITEM	W	E	F	ØD0	K0
DIM(mm)	12.00±0.30	1.75±0.10	5.50±0.10	1.50 ^{+0.10} ₀	1.15±0.10
ITEM	P0	10P0	P1	A0	B0
DIM(mm)	4.00±0.10	40.00±0.20	8.00±0.10	3.05±0.10	2.15±0.10
ITEM	P2	T			
DIM(mm)	2.00±0.10	0.25±0.05			

Note:

- 1) Dimensions are in mm;
- 2) Don't put the vacuum suction nozzle alignment the port hole;
- 3) Tape & Reel Per EIA-481 standard;
- 4) Label applied to external package and directly on reel;
- 5) Static voltage <100V;

Model Number	Reel Diameter	Quantity Per Reel
MSM38A2718Z9EM2	13 inch	5700



RELIABILITY SPECIFICATIONS

Test	Description
Thermal Shock	100 cycles air-to-air thermal shock from -40°C to +125°C with 15 minute soaks.
High Temperature Storage	1,000 hours at +105°C environment
Low Temperature Storage	1,000 hours at -40°C environment
Reflow	5 reflow cycles with peak temperature of +260°C
ESD-HBM	3 discharges of ±2 kV direct contact to I/O pins.
ESD- LID-GND	3 discharges of ±8 kV direct contact to lid while unit is grounded.
ESD-MM	3 discharges of ±200V direct contact to I/O pins.
Vibration	4 cycles of 20 to 2,000 Hz sinusoidal sweep with 20 G peak acceleration lasting 12 minutes in X, Y, and Z directions.
Mechanical Shock	3 pulses of 10,000 G in the X, Y and Z direction
High Temperature Bias	1,000 hours at +105°C under bias
Low Temperature Bias	1,000 hours at -40°C under bias
Temperature/Humidity Bias	1,000 hours at +85°C/85% R.H. under bias.
Drop Test	To be no interference in operation after dropped to 1.0cm steel plate 18 times from 1.5 meter height

NOTE: Sensitivity should vary within ±3dB from initial sensitivity reading. (The measurement is processed at 2 hours after 20±2 °C, R.H 60%~70% condition.)

MSM38A2718Z9EM2
Analog output MEMS microphone



苏州敏芯微电子技术股份有限公司
MEMSensing Microsystems (Suzhou, China) Co., Ltd.



REVISION HISTORY:

Revision	Subjects (major changes since last revision)	Date
1.0	Initial Release	2019-11-18

公司销售、技术支持联系方式

(<http://www.memsensing.com>)

For English:

MEMSensing Microsystems(Suzhou,China)
Co. Ltd.

No. 99 Jinji Lake Avenue, Bldg. NW-09, Suite 501
Suzhou Industrial Park, China 215123

Phone: +86 512 62956055

Fax: +86 512 62956056

中文用户:

苏州敏芯微电子技术股份有限公司

苏州工业园区金鸡湖大道 99 号, NW-09 楼, 501 室
中国 215123

电话: +86 512 62956055

传真: +86 512 62956056

Disclaimer: specifications and characteristics are subject to change without notice. MEMSensing Microsystems Co. Ltd. assumes no liability to any customer, licensee or any third party for any damages or any kind of nature whatsoever related to using this technical data.